

Display CARFAX in online listings: 



This report provided free of charge by:

Ridgeline Automotive LLC

2 Snelson Dr
Asheville, NC 28806

(828) 713-1877











History-Based Value Report

\$16,690

CARFAX Retail Value

History events affecting this vehicle's value

-   1-Owner Vehicle
-   Service History
-   Personal Vehicle
-   Salvage Brand



Vehicle History Report™

US \$44.99

2017 SUBARU OUTBACK 3.6R LIMITED

VIN: 4S4BSENC2H3331428
4 DOOR WAGON/SPORT
UTILITY
3.6L H6 F DOHC 24V
GASOLINE
ALL WHEEL DRIVE

This CARFAX Report Provided
by:
Ridgeline Automotive LLC

 Branded Title: Salvage

 **15** Service history records

 CARFAX 1-Owner vehicle

 Personal vehicle

 Last owned in Florida

 **48,594** Last reported odometer reading

CARFAX HAS THE MOST
ACCIDENT & DAMAGE
INFORMATION



This CARFAX Vehicle History Report is based only on information supplied to CARFAX and available as of 2/18/25 at 3:48:05 PM (CST). Other information about this vehicle, including problems, may not have been reported to CARFAX. Use this report as one important tool, along with a vehicle inspection and test drive, to make a better decision about your next used car.



Accident / Damage History

Not all accidents / issues are reported to CARFAX

Event 1

12/01/2017

Accident reported

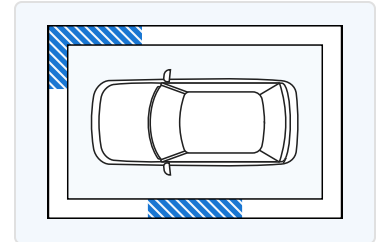

Event 2

08/21/2019

Accident reported

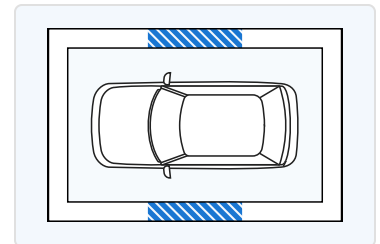

Event 3

08/19/2024

**Accident reported:
minor to moderate
damage**

- It hit a concrete traffic
barrier

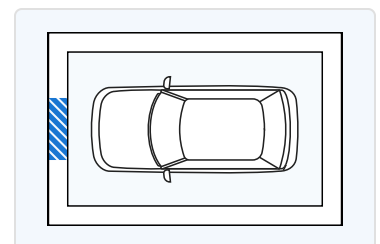
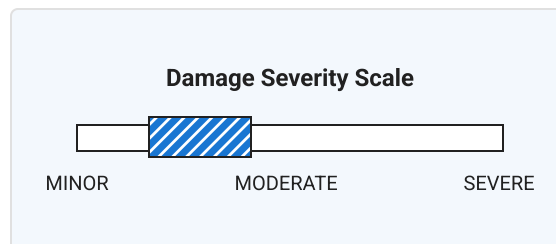



Event 4

11/07/2024

TOTAL LOSS VEHICLE

 Additional History Not all accidents / issues are reported to CARFAX	Owner 1
Total Loss Total Loss Reported: 11/07/2024.	Total Loss Reported
Structural Damage CARFAX recommends that you have this vehicle inspected by a collision repair specialist.	<input checked="" type="checkbox"/> No Issues Reported
Airbag Deployment No airbag deployment reported to CARFAX.	<input checked="" type="checkbox"/> No Issues Reported
Odometer Check No indication of an odometer rollback.	<input checked="" type="checkbox"/> No Issues Indicated
Accident / Damage DMV title problems reported. Accidents reported: 12/01/2017, 08/21/2019, and 08/19/2024.	Severe Damage
Manufacturer Recall No open recalls reported to CARFAX.	<input checked="" type="checkbox"/> No Recalls Reported
Basic Warranty Original manufacturer warranty likely voided by manufacturer.	Warranty Voided

 Title History	Owner 1
Damage Brands Salvage Junk Rebuilt Fire Flood Hail Lemon	Alert! Problem Found
Odometer Brands Not Actual Mileage Exceeds Mechanical Limits	No Problem
 ALERT! - Severe problems were reported by a state Department of Motor Vehicles (DMV). This vehicle does not qualify for the CARFAX Buyback Guarantee.	

 Ownership History The number of owners is estimated	Owner 1
Year purchased	2017
Type of owner	Personal
Estimated length of ownership	7 yrs. 2 mo.
Owned in the following states/provinces	New Jersey, Florida
Estimated miles driven per year	6,725/yr

Last reported odometer reading

48,594



Detailed History





Owner 1

Purchased: 2017

Personal Vehicle
6,725 mi/yr

Date	Mileage	Source	Comments
01/30/2017	12	Ramsey Subaru Saddle River, NJ 201-327-0070 ramseysubaru.net ★ 4.7 / 5.0 1,109 Verified Reviews ♥ 12,853 Customer Favorites	Vehicle serviced - Pre-delivery inspection completed
03/08/2017		Ramsey Subaru Saddle River, NJ 201-327-0070 ramseysubaru.net ★ 4.7 / 5.0 1,109 Verified Reviews ♥ 12,853 Customer Favorites	Vehicle serviced
08/18/2017		New Jersey Motor Vehicle Dept. Tenafly, NJ	Registration issued or renewed - Titled or registered as personal vehicle - Vehicle color noted as Blue
08/21/2017		Ramsey Subaru Saddle River, NJ 201-327-0070 ramseysubaru.net ★ 4.7 / 5.0 1,109 Verified Reviews ♥ 12,853 Customer Favorites	Vehicle sold
08/22/2017		Ramsey Subaru Saddle River, NJ 201-327-0070 ramseysubaru.net ★ 4.7 / 5.0 1,109 Verified Reviews ♥ 12,853 Customer Favorites	Vehicle serviced - Oil and filter changed - Two wheel alignment performed - Vehicle washed/detailed
08/31/2017		Florida Motor Vehicle Dept.	Vehicle purchase reported

08/31/2017	New Jersey Motor Vehicle Dept. Tenafly, NJ Title #RV20172430694	Title issued or updated - First owner reported - Loan or lien reported - Vehicle color noted as Blue
09/11/2017 929	Subaru of Englewood Englewood, NJ 201-568-5200 subaruofenglewood.com / ★ 4.5 / 5.0 260 Verified Reviews ♥ 2,557 Customer Favorites	 Vehicle serviced - Maintenance inspection completed - Vehicle washed/detailed
10/20/2017	New Jersey Motor Vehicle Dept. Tenafly, NJ	Registration issued or renewed - Vehicle color noted as Blue
11/16/2017 3,036	Ramsey Subaru Saddle River, NJ 201-327-0070 ramseysubaru.net ★ 4.7 / 5.0 1,109 Verified Reviews ♥ 12,853 Customer Favorites	 Vehicle serviced
12/01/2017	Damage Report	 Accident reported - Damage to left side - Damage to right front

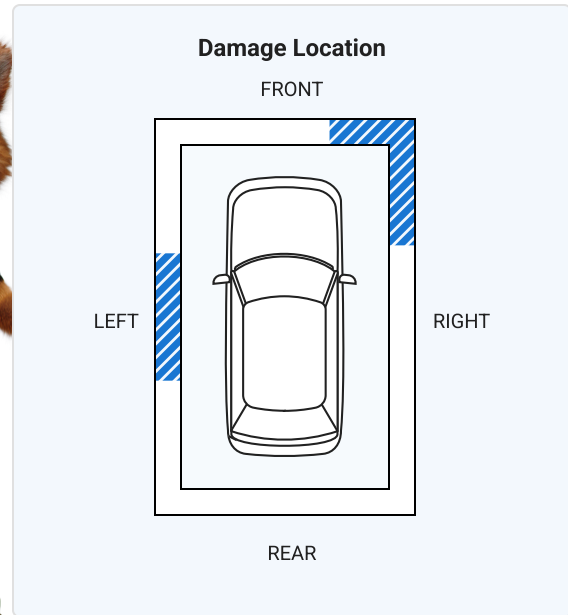

CARFAX HAS THE MOST ACCIDENT & DAMAGE INFORMATION

05/10/2018 6,911

Ramsey Subaru
Saddle River, NJ
201-327-0070
ramseysubaru.net

★ 4.7 / 5.0

1,109 Verified Reviews

♥ 12,853 Customer Favorites



Vehicle serviced

- Oil and filter changed
- One tire replaced
- Safety inspection performed
- Tire(s) replaced

10/17/2018

New Jersey
Motor Vehicle Dept.
Tenafly, NJ

Registration issued or renewed

- Vehicle color noted as Blue

12/14/2018 10,934

Ramsey Subaru
Saddle River, NJ
201-327-0070
ramseysubaru.net

★ 4.7 / 5.0

1,109 Verified Reviews

♥ 12,853 Customer Favorites



Vehicle serviced

- Maintenance inspection completed
- Cabin air filter replaced/cleaned
- Oil and filter changed
- Safety inspection performed

05/21/2019 12,941

Ramsey Subaru
Saddle River, NJ
201-327-0070
ramseysubaru.net

★ 4.7 / 5.0

1,109 Verified Reviews

♥ 12,853 Customer Favorites



Vehicle serviced

- Maintenance inspection completed

08/21/2019

Damage Report



Accident reported

- Damage to left side
- Damage to right side

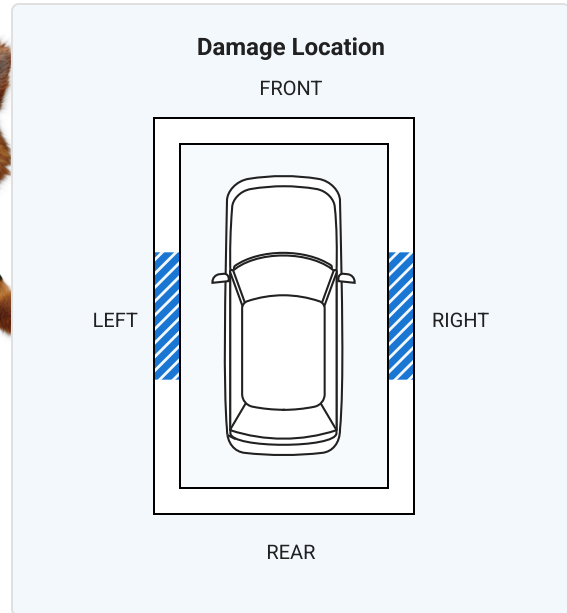

CARFAX HAS THE MOST ACCIDENT & DAMAGE INFORMATION

10/17/2019

New Jersey
Motor Vehicle Dept.
Tenafly, NJ

Registration issued or renewed

- Vehicle color noted as Blue

11/14/2019 15,069

Ramsey Subaru
Saddle River, NJ
201-327-0070
ramseysubaru.net



Vehicle serviced

- Maintenance inspection completed
- Oil and filter changed

★ **4.7 / 5.0**
1,109 Verified Reviews
♥ **12,853** Customer Favorites

02/20/2020 15,748

Ramsey Subaru
Saddle River, NJ
201-327-0070
ramseysubaru.net



Vehicle serviced

- Maintenance inspection completed
- Battery/charging system checked
- Battery replaced





★ **4.7 / 5.0**
1,109 Verified Reviews
♥ **12,853** Customer Favorites

12/15/2020

New Jersey
Motor Vehicle Dept.
Tenafly, NJ

Registration issued or renewed

- Vehicle color noted as Blue

03/17/2021	18,784	Ramsey Subaru Saddle River, NJ 201-327-0070 ramseysubaru.net ★ 4.7 / 5.0 1,109 Verified Reviews ❤️ 12,853 Customer Favorites		Vehicle serviced - Maintenance inspection completed - Battery/charging system checked - Cabin air filter replaced/cleaned - Oil and filter changed - Tires rotated
07/29/2021		Florida Motor Vehicle Dept. Windermere, FL		Registration issued or renewed - Titled or registered as personal vehicle - Registration updated when owner moved the vehicle to a new location - Vehicle color noted as Blue
04/20/2022	30,197	Sport Subaru Orlando, FL 407-291-1448 sportsubaru.com/ ★ 4.8 / 5.0 1,065 Verified Reviews ❤️ 10,539 Customer Favorites		Vehicle serviced - Maintenance inspection completed - Air filter replaced - Cabin air filter replaced/cleaned - Oil and filter changed - Tire condition and pressure checked - Tires rotated - Vehicle washed/detailed
12/15/2022		Florida Motor Vehicle Dept. Windermere, FL Title #0144137513		Registration issued or renewed - Titled or registered as personal vehicle - Vehicle color noted as Blue
04/18/2023	37,802	Sport Subaru Orlando, FL 407-291-1448 sportsubaru.com/ ★ 4.8 / 5.0 1,065 Verified Reviews ❤️ 10,539 Customer Favorites		Vehicle serviced - Maintenance inspection completed - Air filter replaced - Cabin air filter replaced/cleaned - Drivability/performance checked - Oil and filter changed - Tire condition and pressure checked - Tires rotated - Vehicle washed/detailed
06/01/2023		Florida Motor Vehicle Dept. Windermere, FL Title #0144137513		Registration issued or renewed - Titled or registered as personal vehicle - Vehicle color noted as Blue
05/21/2024		Florida Motor Vehicle Dept. Windermere, FL Title #0144137513		Registration issued or renewed - Titled or registered as personal vehicle - Vehicle color noted as Blue
06/13/2024	47,088	Sport Subaru Orlando, FL 407-291-1448 sportsubaru.com/ ★ 4.8 / 5.0		Vehicle serviced - Inspection performed - Alignment checked - Tire checked - Maintenance inspection completed - Air filter replaced

1,065 Verified Reviews
❤️ 10,539 Customer Favorites

- Brakes checked
- Oil and filter changed
- Tires rotated
- Vehicle washed/detailed

[View the complete inspection report](#)

08/19/2024

Damage Report



Accident reported: minor to moderate damage

- It hit a concrete traffic barrier
- Damage to front



CARFAX HAS THE MOST ACCIDENT & DAMAGE INFORMATION

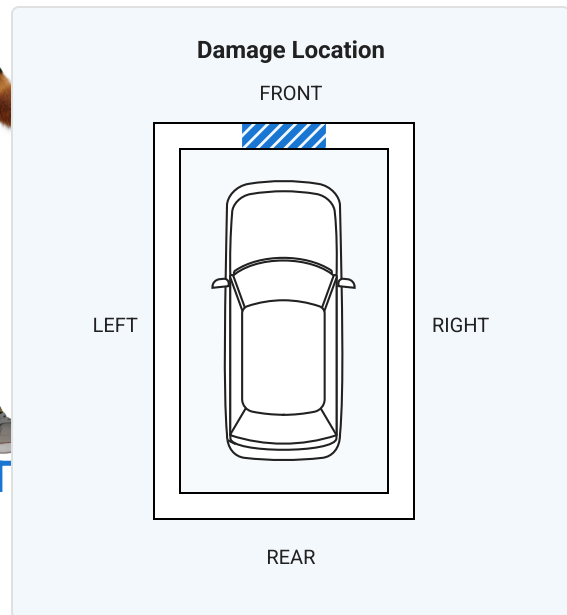
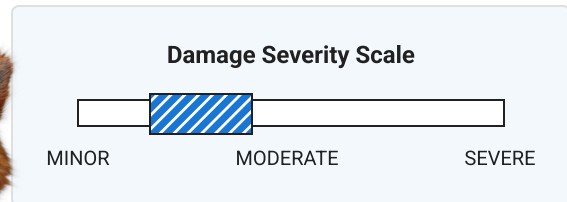

11/06/2024

48,591

Florida
Motor Vehicle Dept.
Sanford, FL

Odometer reading reported

11/07/2024

Damage Report



TOTAL LOSS VEHICLE



There are many reasons an insurance company will declare a vehicle a total loss. Have this vehicle inspected by a qualified technician before you buy. [Learn More](#)

11/07/2024

Florida
Motor Vehicle Dept.

Title or registration issued to insurance company

11/07/2024

Florida
Motor Vehicle Dept.
Sanford, FL



SALVAGE TITLE/CERTIFICATE ISSUED

- Vehicle color noted as Blue

Title #0144137513

11/14/2024

Damage Report



SALVAGE TITLE/CERTIFICATE ISSUED

01/31/2025 48,594

Service Facility



Vehicle serviced

- Alignment performed

Have Questions? Consumers, please visit our Help Center at www.carfax.com. Dealers or Subscribers, please visit our Help Center at www.carfaxonline.com.



Glossary

Accident Indicator

CARFAX receives information about accidents in all 50 states, the District of Columbia and Canada.

Not every accident is reported to CARFAX. As details about the accident become available, those additional details are added to the CARFAX Vehicle History Report. CARFAX recommends that you have this vehicle inspected by a qualified mechanic.

- According to the National Safety Council, Injury Facts, 2021 edition, 5% of the 276 million registered vehicles in the U.S. were involved in an accident in 2019. Over 77% of these were considered minor or moderate.
- This CARFAX Vehicle History Report is based only on information supplied to CARFAX and available as of 2/18/25 at 3:48:05 PM (CST). Other information about this vehicle, including problems, may not have been reported to CARFAX. Use this report as one important tool, along with a vehicle inspection and test drive, to make a better decision about your next used car.

Damage Indicator

Damage can be a result of many different types of events. Examples include contact with objects (other cars, trees, traffic signs, road debris, etc), vandalism, or weather-related events. Not every damage event is reported to CARFAX. As details about the damage event become available, those additional details are added to the CARFAX Vehicle History Report. CARFAX recommends that you have this vehicle inspected by a qualified mechanic.

- This CARFAX Vehicle History Report is based only on information supplied to CARFAX and available as of 2/18/25 at 3:48:05 PM (CST). Other information about this vehicle, including problems, may not have been reported to CARFAX. Use this report as one important tool, along with a vehicle inspection and test drive, to make a better decision about your next used car.

Damage Severity

Damage events result in one of the following severity levels:

- Minor: Generally, minor damage is cosmetic (including dents or scratches), may only require reconditioning, and typically does not compromise a vehicle's operation and/or safety.
- Moderate: Moderate damage may affect multiple components of the vehicle and may impair the vehicle's operation and/or safety.
- Severe: Severe damage usually affects multiple components of the vehicle and is likely to compromise the vehicle's operation and/or safety.

CARFAX recommends getting a pre-purchase inspection at a certified collision repair facility.

First Owner

When the first owner(s) obtains a title from a Department of Motor Vehicles as proof of ownership.

Ownership History

CARFAX defines an owner as an individual or business that possesses and uses a vehicle. Not all title transactions represent changes in ownership. To provide estimated number of owners, CARFAX proprietary technology analyzes all the events in a vehicle history. Estimated ownership is available for vehicles manufactured after 1991 and titled solely in the US including Puerto Rico. Dealers sometimes opt to take ownership of a vehicle and are required to in

the following states: Maine, Massachusetts, New Jersey, Ohio, Oklahoma, Pennsylvania and South Dakota. Please consider this as you review a vehicle's estimated ownership history.

Salvage Title

A Salvage Title is issued on a vehicle damaged to the extent that the cost of repairing the vehicle exceeds approximately 75% of its pre-damage value. This damage threshold may vary by state. Some states treat Junk titles the same as Salvage but the majority use this title to indicate that a vehicle is not road worthy and cannot be titled again in that state. The following eleven states also use Salvage titles to identify stolen vehicles - AZ, FL, GA, IL, MD, MN, NJ, NM, NY, OK and OR.

Title Issued

A state issues a title to provide a vehicle owner with proof of ownership. Each title has a unique number. Each title or registration record on a CARFAX report does not necessarily indicate a change in ownership. In Canada, a registration and bill of sale are used as proof of ownership.

Total Loss Vehicle

An insurance or fleet company declares a vehicle a total loss when a claim exceeds approximately 75% of its pre-damage value or if the vehicle is stolen and not recovered. This damage threshold varies by company. These companies typically take possession and obtain the title. Not all total loss vehicles result in a DMV-reported branded title. This may occur when an insurance company's definition of a total loss is different than the state DMV's definition for a branded title or when the owner of the vehicle is a self-insured company, like a fleet or rental company.

Follow Us:



facebook.com/CARFAX



[@CARFAXinc](https://twitter.com/CARFAXinc)



About CARFAX

CARFAX DEPENDS ON ITS SOURCES FOR THE ACCURACY AND RELIABILITY OF ITS INFORMATION. THEREFORE, NO RESPONSIBILITY IS ASSUMED BY CARFAX OR ITS AGENTS FOR ERRORS OR OMISSIONS IN THIS REPORT. CARFAX FURTHER EXPRESSLY DISCLAIMS ALL WARRANTIES, EXPRESS OR IMPLIED, INCLUDING ANY IMPLIED WARRANTIES OF MERCHANTABILITY OR FITNESS FOR A PARTICULAR PURPOSE.

© 2025 CARFAX, Inc., part of S&P Global. All rights reserved.
2/18/25 3:48:05 PM (CST)

I have reviewed and received a copy of the CARFAX Vehicle History Report for this 2017 SUBARU OUTBACK vehicle (VIN: 4S4BSENC2H3331428), which is based on information supplied to CARFAX and available as of 2/18/25 at 4:48 PM (EST).

Customer Signature

Date

Dealer Signature

Date