



This report provided free of charge by:

**Ridgeline Automotive LLC**

2 Snelson Dr  
Asheville, NC 28806

(828) 713-1877



## Report

US \$44.99

### 2022 Subaru Crosstrek Limited

12,683 mi | VIN: JF2GTHNC6NH281657 |

4 Door Wagon/Sport Utility | 2.5L H4 F DOHC 16V | Gasoline | All wheel drive

CARFAX HAS THE MOST  
ACCIDENT & DAMAGE  
INFORMATION



BRANDED TITLE

Salvage

2 Service history records

1 CARFAX 1-Owner vehicle

Personal vehicle

Last owned in New York

10 Detailed records available

This CARFAX Vehicle History Report is based only on information supplied to CARFAX and available as of 4/8/26 at 3:24:34 PM (CDT). Other information about this vehicle, including problems, may not have been reported to CARFAX. Use this report as one important tool, along with a vehicle inspection and test drive, to make a better decision about your next used car.



### Accident / Damage History

Not all accidents / issues are reported to CARFAX

#### Event 1

09/28/2023

**Damage reported: minor damage**

#### Damage Severity Scale

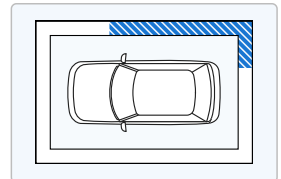
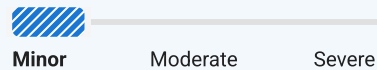

#### Event 2

11/11/2025

**Accident reported: moderate to severe damage**

- Disabling damage reported
- Vehicle towed
- Side airbag deployed

#### Damage Severity Scale

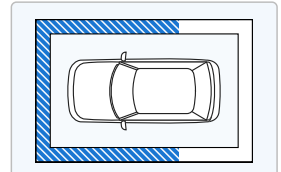

#### Event 3

11/11/2025

### TOTAL LOSS VEHICLE

- Vehicle declared a total loss by an insurance company
- Collision damage reported



### Recent Service Highlights

Key services performed in the last 12 months

| Service | Comments              | Date       |
|---------|-----------------------|------------|
| Tires   | ✓ Alignment performed | 04/03/2026 |

This car has been recently serviced. That's a good thing!



### Additional History

Not all accidents / issues are reported to CARFAX

Owner 1

#### Total Loss

Total Loss Reported: 11/11/2025.

Total Loss Reported

#### Structural Damage

CARFAX recommends that you have this vehicle inspected by a collision repair specialist.

✓ No Issues Reported

#### Airbag Deployment

Airbag deployment reported: 11/11/2025.

Airbag Deployment

#### Odometer Check

No indication of an odometer rollback.

✓ No Issues Indicated

#### Accident / Damage

DMV title problems reported. Damage reported: 09/28/2023. Accident reported: 11/11/2025.

Severe Damage

#### Manufacturer Recall

No open recalls reported to CARFAX.

✓ No Recalls Reported

#### Basic Warranty

Original manufacturer warranty likely voided by manufacturer.

Warranty Voided



### Title History

Owner 1

#### Damage Brands

Salvage | Junk | Rebuilt | Fire | Flood | Hail | Lemon

**Alert!**  
Problem Found

#### Odometer Brands

Not Actual Mileage | Exceeds Mechanical Limits

No Problem



**ALERT!** - Severe problems were reported by a state Department of Motor Vehicles (DMV). This vehicle does not qualify for the CARFAX Buyback Guarantee.



### Ownership History

The number of owners is estimated

Owner 1

Year purchased

2022

Type of owner

Personal

Estimated length of ownership

3 yrs. 4 mo.

|   |                      |
|---|----------------------|
| Owned in the following states/provinces | New Jersey, New York |
| Estimated miles driven per year         | ---                  |
| Last reported odometer reading          | 12,683               |

**CARFAX** Detailed History

**Owner 1** Personal Vehicle  
Purchased: 2022

| Date       | Mileage | Source  | Comments  |
|------------|---------|---|---|
| 07/15/2022 | 5       | Lynnes Subaru<br>Bloomfield, NJ<br>973-233-8291<br>lynnessubaru.com<br>★ 4.6 / 5.0 491 Verified Reviews<br>♥ 3,316 Customer Favorites | <b>Vehicle serviced</b><br>- Pre-delivery inspection completed<br>- Vehicle washed/detailed   |
| 08/01/2022 |         | New Jersey<br>Motor Vehicle Dept.<br>Carlstadt, NJ<br>Title #GD20222131994  | <b>Title issued or updated</b><br>- Registration issued or renewed<br>- First owner reported<br>- Titled or registered as personal vehicle<br>- Loan or lien reported<br>- Vehicle color noted as White |
| 09/28/2023 |         | Damage Report   | <b>Damage reported: minor damage</b><br>- Damage to right rear<br>- Damage to right side  |

**CARFAX HAS THE MOST ACCIDENT & DAMAGE INFORMATION**

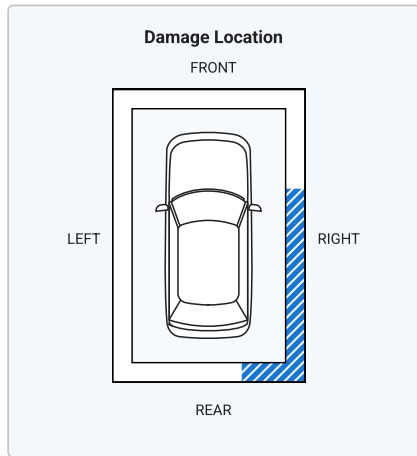
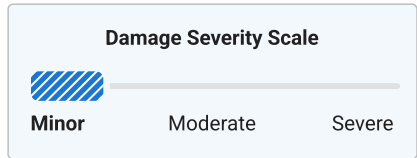



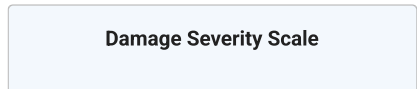

|            |  |               |  |
|------------|--|---------------|--|
| 11/11/2025 |  | Damage Report | <b>Accident reported: moderate to severe damage</b><br>- Damage to front<br>- Damage to left front<br>- Damage to left side<br>- Damage to right front<br>- Damage to right side<br>- Disabling damage reported<br>- Vehicle towed<br>- Side airbag deployed<br>CARFAX Airbag Tips |
|------------|--|---------------|--|

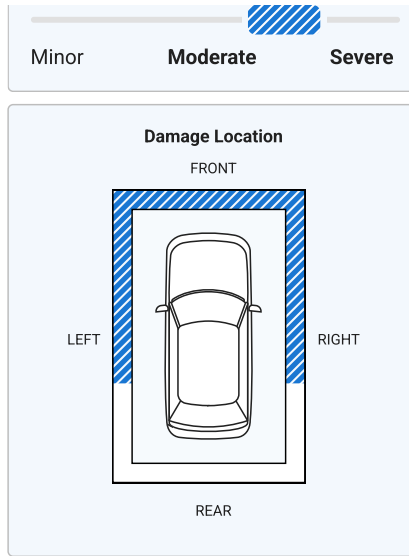

## CARFAX HAS THE MOST ACCIDENT & DAMAGE INFORMATION



|            |        |   |   |   |
|------------|--------|---|---|---|
| 11/11/2025 |        | Damage Report   |    | <b>TOTAL LOSS VEHICLE</b><br>- Vehicle declared a total loss by an insurance company<br>- Collision damage reported   |
|            |        |    |   | There are many reasons an insurance company will declare a vehicle a total loss. Have this vehicle inspected by a qualified technician before you buy. <a href="#">Learn More</a> |
| 12/31/2025 |        | New York Motor Vehicle Dept.  |   | <b>Title or registration issued to insurance company</b>  |
| 12/31/2025 |        | Damage Report   |    | <b>SALVAGE TITLE/CERTIFICATE ISSUED</b>   |
| 12/31/2025 |        | New York Motor Vehicle Dept. Albany, NY   |  | <b>SALVAGE TITLE/CERTIFICATE ISSUED</b>   |
| 01/01/2026 |        | Auto Auction  |   | <b>Vehicle sold</b>   |
| 04/03/2026 | 12,683 | Import Concepts II Asheville, NC<br>828-258-2256<br>importconcepts2.com/<br>★ <b>4.9 / 5.0</b> 166 Verified Reviews<br>♥ <b>13</b> Customer Favorites |  | <b>Vehicle serviced</b><br>- Alignment performed  |

Have Questions? Consumers, please visit our Help Center at [www.carfax.com](http://www.carfax.com). Dealers or Subscribers, please visit our Help Center at [www.carfaxonline.com](http://www.carfaxonline.com).

## Glossary

### Accident Indicator

CARFAX receives information about accidents in all 50 states, the District of Columbia and Canada.

Not every accident is reported to CARFAX. As details about the accident become available, those additional details are added to the CARFAX Vehicle History Report. CARFAX recommends that you have this vehicle inspected by a qualified mechanic.

- According to the National Safety Council, Injury Facts, 2021 edition, 5% of the 276 million registered vehicles in the U.S. were involved in an accident in 2019. Over 77% of these were considered minor or moderate.
- This CARFAX Vehicle History Report is based only on information supplied to CARFAX and available as of 4/8/26 at 3:24:34 PM (CDT). Other information about this vehicle, including problems, may not have been reported to CARFAX. Use this report as one important tool, along with a vehicle inspection and test drive, to make a better decision about your next used car.

### Airbag Deployment

Occurs when the driver, passenger or side airbag has been used or deployed during a crash or other incident. If an airbag has been deployed, it must be replaced by a qualified technician. Have this car inspected by a mechanic prior to purchase.

### Damage Indicator

Damage can be a result of many different types of events. Examples include contact with objects (other cars, trees, traffic signs, road debris, etc), vandalism, or weather-related events. Not every damage event is reported to CARFAX. As details about the damage event become available, those additional details are added to the CARFAX Vehicle History Report. CARFAX recommends that you have this vehicle inspected by a qualified mechanic.

- This CARFAX Vehicle History Report is based only on information supplied to CARFAX and available as of 4/8/26 at 3:24:34 PM (CDT). Other information about this vehicle, including problems, may not have been reported to CARFAX. Use this report as one important tool, along with a vehicle inspection and test drive, to make a better decision about your next used car.

#### Damage Severity

Damage events result in one of the following severity levels:

- Minor: Generally, minor damage is cosmetic (including dents or scratches), may only require reconditioning, and typically does not compromise a vehicle's operation and/or safety.
- Moderate: Moderate damage may affect multiple components of the vehicle and may impair the vehicle's operation and/or safety.
- Severe: Severe damage usually affects multiple components of the vehicle and is likely to compromise the vehicle's operation and/or safety.

CARFAX recommends getting a pre-purchase inspection at a certified collision repair facility.

#### First Owner

When the first owner(s) obtains a title from a Department of Motor Vehicles as proof of ownership.

#### Ownership History

CARFAX defines an owner as an individual or business that possesses and uses a vehicle. Not all title transactions represent changes in ownership. To provide estimated number of owners, CARFAX proprietary technology analyzes all the events in a vehicle history. Estimated ownership is available for vehicles manufactured after 1991 and titled solely in the US including Puerto Rico. Dealers sometimes opt to take ownership of a vehicle and are required to in the following states: Maine, Massachusetts, New Jersey, Ohio, Oklahoma, Pennsylvania and South Dakota. Please consider this as you review a vehicle's estimated ownership history.

#### Salvage Title



A Salvage Title is issued on a vehicle damaged to the extent that the cost of repairing the vehicle exceeds approximately 75% of its pre-damage value. This damage threshold may vary by state. Some states treat Junk titles the same as Salvage but the majority use this title to indicate that a vehicle is not road worthy and cannot be titled again in that state. The following eleven states also use Salvage titles to identify stolen vehicles - AZ, FL, GA, IL, MD, MN, NJ, NM, NY, OK and OR.

#### Title Issued

A state issues a title to provide a vehicle owner with proof of ownership. Each title has a unique number. Each title or registration record on a CARFAX report does not necessarily indicate a change in ownership. In Canada, a registration and bill of sale are used as proof of ownership.

#### Total Loss Vehicle

An insurance or fleet company declares a vehicle a total loss when a claim exceeds approximately 75% of its pre-damage value or if the vehicle is stolen and not recovered. This damage threshold varies by company. These companies typically take possession and obtain the title. Not all total loss vehicles result in a DMV-reported branded title. This may occur when an insurance company's definition of a total loss is different than the state DMV's definition for a branded title or when the owner of the vehicle is a self-insured company, like a fleet or rental company.

Follow Us:  [facebook.com/CARFAX](https://facebook.com/CARFAX)  [@CARFAXinc](https://twitter.com/CARFAXinc)  [About CARFAX](#)

CARFAX DEPENDS ON ITS SOURCES FOR THE ACCURACY AND RELIABILITY OF ITS INFORMATION. THEREFORE, NO RESPONSIBILITY IS ASSUMED BY CARFAX OR ITS AGENTS FOR ERRORS OR OMISSIONS IN THIS REPORT. CARFAX FURTHER EXPRESSLY DISCLAIMS ALL WARRANTIES, EXPRESS OR IMPLIED, INCLUDING ANY IMPLIED WARRANTIES OF MERCHANTABILITY OR FITNESS FOR A PARTICULAR PURPOSE.

© 2026 CARFAX, Inc., part of S&P Global. All rights reserved.  
4/8/26 3:24:34 PM (CDT)

I have reviewed and received a copy of the CARFAX Vehicle History Report for this 2022 SUBARU CROSSTREK vehicle (VIN: JF2GTHNC6NH281657), which is based on information supplied to CARFAX and available as of 4/8/26 at 4:24 PM (EDT).

\_\_\_\_\_  
Customer Signature

\_\_\_\_\_  
Date

\_\_\_\_\_  
Dealer Signature

\_\_\_\_\_  
Date