



This report provided free of charge by:

Ridgeline Automotive LLC

2 Snelson Dr
Asheville, NC 28806

(828) 713-1877



Report

US \$44.99

2015 Dodge Grand Caravan SXT

72,070 mi | VIN: 2C4RDGCG5FR550399 |

Van | 3.6L V6 F DOHC 24V | Gasoline | Front wheel drive

CARFAX HAS THE MOST
ACCIDENT & DAMAGE
INFORMATION



BRANDED TITLE

Salvage, Reconstructed, Rebuilt

24 Service History Records

2 Previous Owners

Personal Vehicle

Last Owned in North Carolina

49 Detailed Records Available

This CARFAX Vehicle History Report is based only on information supplied to CARFAX and available as of 6/1/26 at 12:02:04 PM (CDT). Other information about this vehicle, including problems, may not have been reported to CARFAX. Use this report as one important tool, along with a vehicle inspection and test drive, to make a better decision about your next used car.



Accident / Damage History

Not all accidents / issues are reported to CARFAX

Event 1

08/20/2021

Damage reported: minor damage

Damage Severity Scale



Minor

Moderate

Severe

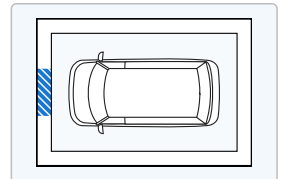

Event 2

05/31/2025

Accident reported: minor to moderate damage

- Vehicle ran off road
- It hit a tree
- It hit a sign
- Disabling damage reported
- Vehicle towed
- Airbags did not deploy

Damage Severity Scale



Minor

Moderate

Severe

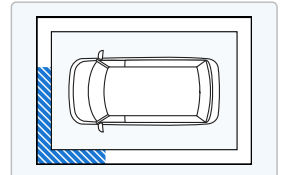







Event 3

05/31/2025

TOTAL LOSS VEHICLE



- Vehicle declared a total loss by an insurance company
- Non-collision damage reported



 Additional History Not all accidents / issues are reported to CARFAX	 Owner 1	 Owner 2
Total Loss Total Loss Reported: 05/31/2025.	Total Loss Reported	No New Issues Reported
Structural Damage CARFAX recommends that you have this vehicle inspected by a collision repair specialist.	<input checked="" type="checkbox"/> No Issues Reported	<input checked="" type="checkbox"/> No Issues Reported
Airbag Deployment No airbag deployment reported to CARFAX.	<input checked="" type="checkbox"/> No Issues Reported	<input checked="" type="checkbox"/> No Issues Reported
Odometer Check No indication of an odometer rollback.	<input checked="" type="checkbox"/> No Issues Indicated	<input checked="" type="checkbox"/> No Issues Indicated
Accident / Damage DMV title problems reported. Damage reported: 08/20/2021. Accident reported: 05/31/2025.	Accident Reported	Severe Damage
Manufacturer Recall No open recalls reported to CARFAX.	<input checked="" type="checkbox"/> No Recalls Reported	<input checked="" type="checkbox"/> No Recalls Reported
Basic Warranty Original manufacturer warranty likely voided by manufacturer.	<input checked="" type="checkbox"/> Warranty Active	Warranty Voided





 Title History	 Owner 1	 Owner 2
Damage Brands Salvage Junk Rebuilt Fire Flood Hail Lemon	No Problem	Alert! Problem Found
Odometer Brands Not Actual Mileage Exceeds Mechanical Limits	No Problem	No Problem











ALERT! - Severe problems were reported by a state Department of Motor Vehicles (DMV). This vehicle does not qualify for the CARFAX Buyback Guarantee.

 Ownership History The number of owners is estimated	 Owner 1	 Owner 2
Year purchased	2014	2025
Type of owner	Personal	Personal
Estimated length of ownership	10 yrs. 5 mo.	7 days
Owned in the following states/provinces	South Carolina	South Carolina, North Carolina
Estimated miles driven per year	7,146/yr	---
Last reported odometer reading	66,354	72,070

 Detailed History
 Owner 1 Purchased: 2014 Personal Vehicle 7,146 mi/yr

Date	Mileage	Source	Comments
09/29/2014		Benson Chrysler Dodge Greer, SC 864-877-0161 benson.fivestardealers.com ★ 4.6 / 5.0 464 Verified Reviews ♥ 5,162 Customer Favorites	Vehicle offered for sale
09/29/2014	11	Benson Chrysler Dodge Jeep Alfa Romeo Fiat Greer, SC 864-877-0161 bensoncdj.com ★ 4.6 / 5.0 464 Verified Reviews ♥ 5,162 Customer Favorites	 Vehicle serviced - Pre-delivery inspection completed
12/29/2014	17	Benson Chrysler Dodge Jeep Alfa Romeo Fiat Greer, SC 864-877-0161 bensoncdj.com ★ 4.6 / 5.0 464 Verified Reviews ♥ 5,162 Customer Favorites	Vehicle sold
12/29/2014		South Carolina Motor Vehicle Dept.	Vehicle purchase reported
01/23/2015		South Carolina Motor Vehicle Dept. Spartanburg, SC Title #770490289961362	Title issued or updated - Registration issued or renewed - First owner reported - Titled or registered as personal vehicle
06/15/2015	4,256	Harris Automotive, Inc. Spartanburg, SC 864-583-9428 ★ 5.0 / 5.0 267 Verified Reviews ♥ 1,430 Customer Favorites	 Vehicle serviced - Four tires balanced - Four tires mounted - Tire valve stem(s)/core(s) replaced
07/13/2015	4,838	Benson Chrysler Dodge Jeep Alfa Romeo Fiat Greer, SC 864-877-0161 bensoncdj.com ★ 4.6 / 5.0 464 Verified Reviews ♥ 5,162 Customer Favorites	 Vehicle serviced - Maintenance inspection completed - Oil and filter changed
11/11/2015	8,305	Benson Chrysler Dodge Jeep Alfa Romeo Fiat Greer, SC 864-877-0161 bensoncdj.com ★ 4.6 / 5.0 464 Verified Reviews ♥ 5,162 Customer Favorites	 Vehicle serviced - Maintenance inspection completed
11/30/2015	8,769	Benson Chrysler Dodge Jeep Alfa Romeo Fiat Greer, SC 864-877-0161 bensoncdj.com ★ 4.6 / 5.0 464 Verified Reviews ♥ 5,162 Customer Favorites	 Vehicle serviced - Maintenance inspection completed
01/26/2016		South Carolina Motor Vehicle Dept. Spartanburg, SC Title #770490289961362	Registration issued or renewed

05/05/2016	11,813	Benson Chrysler Dodge Jeep Alfa Romeo Fiat Greer, SC 864-877-0161 bensoncdj.com ★ 4.6 / 5.0 464 Verified Reviews ♥ 5,162 Customer Favorites		Vehicle serviced - Maintenance inspection completed - Computer reprogrammed - Oil and filter changed
07/25/2016	14,834	Benson Chrysler Dodge Jeep Alfa Romeo Fiat Greer, SC 864-877-0161 bensoncdj.com ★ 4.6 / 5.0 464 Verified Reviews ♥ 5,162 Customer Favorites		Vehicle serviced - Computer reprogrammed
08/31/2016	15,613	Bolton-James Alignment, Inc. Spartanburg, SC 864-585-0694 boltonjames.com/ ★ 4.9 / 5.0 441 Verified Reviews ♥ 1,539 Customer Favorites		Vehicle serviced - Tire repaired
12/02/2016	20,902	Benson Chrysler Dodge Jeep Alfa Romeo Fiat Greer, SC 864-877-0161 bensoncdj.com ★ 4.6 / 5.0 464 Verified Reviews ♥ 5,162 Customer Favorites		Vehicle serviced - Maintenance inspection completed - Oil and filter changed - Tires rotated
01/13/2017		South Carolina Motor Vehicle Dept. Spartanburg, SC Title #770490289961362		Registration issued or renewed
04/18/2017	24,117	Harris Automotive, Inc. Spartanburg, SC 864-583-9428 ★ 5.0 / 5.0 267 Verified Reviews ♥ 1,430 Customer Favorites		Vehicle serviced - Maintenance inspection completed - Oil and filter changed
12/14/2017	27,121	Benson Chrysler Dodge Jeep Alfa Romeo Fiat Greer, SC 864-877-0161 bensoncdj.com ★ 4.6 / 5.0 464 Verified Reviews ♥ 5,162 Customer Favorites		Vehicle serviced - Fuel system checked
01/29/2018		South Carolina Motor Vehicle Dept. Spartanburg, SC Title #770490289961362		Registration issued or renewed
04/11/2018	29,822	Harris Automotive, Inc. Spartanburg, SC 864-583-9428 ★ 5.0 / 5.0 267 Verified Reviews ♥ 1,430 Customer Favorites		Vehicle serviced - Tires rotated
07/05/2018	31,196	Harris Automotive, Inc. Spartanburg, SC 864-583-9428 ★ 5.0 / 5.0 267 Verified Reviews ♥ 1,430 Customer Favorites		Vehicle serviced - Oil and filter changed
01/16/2019		South Carolina		Registration issued or renewed

Motor Vehicle Dept.
Spartanburg, SC
Title #770490289961362

11/05/2019

38,486

Harris Automotive, Inc.
Spartanburg, SC
864-583-9428

★ 5.0 / 5.0 267 Verified Reviews
♥ 1,430 Customer Favorites



Vehicle serviced
- Oil and filter changed

12/26/2019

39,495

Benson Chrysler Dodge Jeep Alfa
Romeo Fiat
Greer, SC
864-877-0161
bensonchryslerdodgejeep.com/

★ 4.6 / 5.0 464 Verified Reviews
♥ 5,162 Customer Favorites



Vehicle serviced
- Maintenance inspection completed
- Engine checked

01/09/2020

South Carolina
Motor Vehicle Dept.
Spartanburg, SC
Title #770490289961362

Registration issued or renewed

08/13/2020

43,004

Harris Automotive, Inc.
Spartanburg, SC
864-583-9428

★ 5.0 / 5.0 267 Verified Reviews
♥ 1,430 Customer Favorites



Vehicle serviced
- One tire balanced
- Tire repaired
- Tire(s) balanced

09/09/2020

43,255

Harris Automotive, Inc.
Spartanburg, SC
864-583-9428

★ 5.0 / 5.0 267 Verified Reviews
♥ 1,430 Customer Favorites



Vehicle serviced
- One tire balanced
- Tire repaired
- Tire(s) balanced

11/12/2020

44,254

Harris Automotive, Inc.
Spartanburg, SC
864-583-9428

★ 5.0 / 5.0 267 Verified Reviews
♥ 1,430 Customer Favorites



Vehicle serviced
- Oil and filter changed

02/01/2021

South Carolina
Motor Vehicle Dept.
Spartanburg, SC
Title #770490289961362

Registration issued or renewed

08/10/2021

50,350

Harris Automotive, Inc.
Spartanburg, SC
864-583-9428
harrisautomotiveservices.com/

★ 5.0 / 5.0 267 Verified Reviews
♥ 1,430 Customer Favorites



Vehicle serviced
- Oil and filter changed

08/20/2021

Damage Report

Damage reported: minor damage
- Damage to front

Damage Severity Scale







Minor

Moderate

Severe

**CARFAX HAS THE MOST
ACCIDENT & DAMAGE
INFORMATION**



12/01/2021	52,556	Harris Automotive, Inc. Spartanburg, SC 864-583-9428 harrisautomotiveservices.com/ ★ 5.0 / 5.0 267 Verified Reviews ♥ 1,430 Customer Favorites		Vehicle serviced - Intake manifold gasket(s) replaced - Oil and filter changed
01/26/2022		South Carolina Motor Vehicle Dept. Spartanburg, SC Title #770490289961362		Registration issued or renewed
05/02/2022		South Carolina Motor Vehicle Dept. Spartanburg, SC Title #770490289961362		Registration issued or renewed
07/05/2022	56,218	Harris Automotive, Inc. Spartanburg, SC 864-583-9428 harrisautomotiveservices.com/ ★ 5.0 / 5.0 267 Verified Reviews ♥ 1,430 Customer Favorites		Vehicle serviced - Oil and filter changed
01/05/2023		South Carolina Motor Vehicle Dept. Spartanburg, SC Title #770490289961362		Registration issued or renewed
05/10/2023	61,305	Harris Automotive, Inc. Spartanburg, SC 864-583-9428 harrisautomotiveservices.com/ ★ 5.0 / 5.0 267 Verified Reviews ♥ 1,430 Customer Favorites		Vehicle serviced - Oil and filter changed
07/25/2023		South Carolina Motor Vehicle Dept. Spartanburg, SC Title #770870447746146		Title issued or updated
01/17/2024		South Carolina Motor Vehicle Dept. Spartanburg, SC Title #770870447746146		Registration issued or renewed
04/09/2024	66,354	Harris Automotive, Inc. Spartanburg, SC 864-583-9428 harrisautomotiveservices.com/ ★ 5.0 / 5.0 267 Verified Reviews ♥ 1,430 Customer Favorites		Vehicle serviced - Oil and filter changed
01/02/2025		South Carolina		Registration issued or renewed

Motor Vehicle Dept.
Spartanburg, SC
Title #770870447746146

05/31/2025

Damage Report



Accident reported: minor to moderate damage

- Vehicle ran off road
- It hit a tree
- It hit a sign
- Damage to front
- Damage to left front
- Disabling damage reported
- Vehicle towed
- Airbags did not deploy

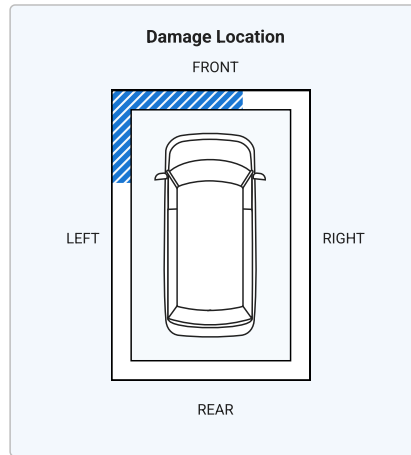
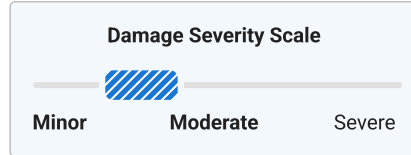

CARFAX HAS THE MOST ACCIDENT & DAMAGE INFORMATION

05/31/2025

Damage Report



TOTAL LOSS VEHICLE

- Vehicle declared a total loss by an insurance company
- Non-collision damage reported

There are many reasons an insurance company will declare a vehicle a total loss. Have this vehicle inspected by a qualified technician before you buy. [Learn More](#)

Owner 2
Purchased: 2025

Personal Vehicle

Date	Mileage	Source	Comments
06/18/2025		South Carolina Motor Vehicle Dept. Spartanburg, SC Title #770870488137346	Title issued or updated - New owner reported
06/25/2025		South Carolina Motor Vehicle Dept.	Vehicle purchase reported
07/06/2025		South Carolina Motor Vehicle Dept.	Title or registration issued to insurance company
07/06/2025	72,012	South Carolina Motor Vehicle Dept. Spartanburg, SC Title #770760489121706	SALVAGE TITLE/CERTIFICATE ISSUED
07/11/2025		Damage Report	SALVAGE TITLE/CERTIFICATE ISSUED
07/23/2025		North Carolina Motor Vehicle Dept. Asheville, NC	Dealer took title of this vehicle while it was in inventory - SALVAGE TITLE/CERTIFICATE ISSUED

Title #609829252049907

- RECONSTRUCTED TITLE ISSUED
- REBUILT TITLE ISSUED

04/06/2026

72,070

Tip-Top Auto Llc
Asheville, NC
828-882-9095
tiptopautonc.com/



Vehicle serviced

- Emissions inspection performed

Have Questions? Consumers, please visit our Help Center at www.carfax.com. Dealers or Subscribers, please visit our Help Center at www.carfaxonline.com.



Glossary

Accident Indicator

CARFAX receives information about accidents in all 50 states, the District of Columbia and Canada.

Not every accident is reported to CARFAX. As details about the accident become available, those additional details are added to the CARFAX Vehicle History Report. CARFAX recommends that you have this vehicle inspected by a qualified mechanic.

- According to the National Safety Council, Injury Facts, 2021 edition, 5% of the 276 million registered vehicles in the U.S. were involved in an accident in 2019. Over 77% of these were considered minor or moderate.
- This CARFAX Vehicle History Report is based only on information supplied to CARFAX and available as of 6/1/26 at 12:02:04 PM (CDT). Other information about this vehicle, including problems, may not have been reported to CARFAX. Use this report as one important tool, along with a vehicle inspection and test drive, to make a better decision about your next used car.

Damage Indicator

Damage can be a result of many different types of events. Examples include contact with objects (other cars, trees, traffic signs, road debris, etc), vandalism, or weather-related events. Not every damage event is reported to CARFAX. As details about the damage event become available, those additional details are added to the CARFAX Vehicle History Report. CARFAX recommends that you have this vehicle inspected by a qualified mechanic.

- This CARFAX Vehicle History Report is based only on information supplied to CARFAX and available as of 6/1/26 at 12:02:04 PM (CDT). Other information about this vehicle, including problems, may not have been reported to CARFAX. Use this report as one important tool, along with a vehicle inspection and test drive, to make a better decision about your next used car.

Damage Severity

Damage events result in one of the following severity levels:

- Minor: Generally, minor damage is cosmetic (including dents or scratches), may only require reconditioning, and typically does not compromise a vehicle's operation and/or safety.
- Moderate: Moderate damage may affect multiple components of the vehicle and may impair the vehicle's operation and/or safety.
- Severe: Severe damage usually affects multiple components of the vehicle and is likely to compromise the vehicle's operation and/or safety.

CARFAX recommends getting a pre-purchase inspection at a certified collision repair facility.

First Owner

When the first owner(s) obtains a title from a Department of Motor Vehicles as proof of ownership.

New Owner Reported

When a vehicle is sold to a new owner, the Title must be transferred to the new owner(s) at a Department of Motor Vehicles.

Ownership History

CARFAX defines an owner as an individual or business that possesses and uses a vehicle. Not all title transactions represent changes in ownership. To provide estimated number of owners, CARFAX proprietary technology analyzes all the events in a vehicle history. Estimated ownership is available for vehicles manufactured after 1991 and titled solely in the US including Puerto Rico. Dealers sometimes opt to take ownership of a vehicle and are required to in the following states: Maine, Massachusetts, New Jersey, Ohio, Oklahoma, Pennsylvania and South Dakota. Please consider this as you review a vehicle's estimated ownership history.

Rebuilt/Reconstructed Title

A Rebuilt/Reconstructed vehicle is a salvage vehicle that has been repaired and restored to operation. These vehicles are often severely damaged before they are rebuilt and refurbished parts are typically used during reconstruction. In most states, an inspection of the vehicle is required before the vehicle is allowed to return to the road.

Salvage Title

A Salvage Title is issued on a vehicle damaged to the extent that the cost of repairing the vehicle exceeds approximately 75% of its pre-damage value. This damage threshold may vary by state. Some states treat Junk titles the same as Salvage but the majority use this title to indicate that a vehicle is not road worthy and cannot be titled again in that state. The following eleven states also use Salvage titles to identify stolen vehicles - AZ, FL, GA, IL, MD, MN, NJ, NM, NY, OK and OR.

Title Issued

A state issues a title to provide a vehicle owner with proof of ownership. Each title has a unique number. Each title or registration record on a CARFAX report does not necessarily indicate a change in ownership. In Canada, a registration and bill of sale are used as proof of ownership.

Total Loss Vehicle

An insurance or fleet company declares a vehicle a total loss when a claim exceeds approximately 75% of its pre-damage value or if the vehicle is stolen and not recovered. This damage threshold varies by company. These companies typically take possession and obtain the title. Not all total loss vehicles result in a DMV-reported branded title. This may occur when an insurance company's definition of a total loss is different than the state DMV's definition for a branded title or when the owner of the vehicle is a self-insured company, like a fleet or rental company.

Follow Us: [facebook.com/CARFAX](https://www.facebook.com/CARFAX) [@CARFAXinc](https://twitter.com/CARFAXinc) [About CARFAX](#)

CARFAX DEPENDS ON ITS SOURCES FOR THE ACCURACY AND RELIABILITY OF ITS INFORMATION. THEREFORE, NO RESPONSIBILITY IS ASSUMED BY CARFAX OR ITS AGENTS FOR ERRORS OR OMISSIONS IN THIS REPORT. CARFAX FURTHER EXPRESSLY DISCLAIMS ALL WARRANTIES, EXPRESS OR IMPLIED, INCLUDING ANY IMPLIED WARRANTIES OF MERCHANTABILITY OR FITNESS FOR A PARTICULAR PURPOSE.

© 2026 CARFAX, Inc., part of S&P Global. All rights reserved.
6/1/26 12:02:04 PM (CDT)

I have reviewed and received a copy of the CARFAX Vehicle History Report for this 2015 DODGE GRAND CARAVAN vehicle (VIN: 2C4RDGCG5FR550399), which is based on information supplied to CARFAX and available as of 6/1/26 at 1:02 PM (EDT).

Customer Signature

Date

Dealer Signature

Date