



This report provided free of charge by:

**Ridgeline Automotive LLC**

2 Snelson Dr  
Asheville, NC 28806

(828) 713-1877



## Report

US \$44.99

### 2020 Ford Transit 250

21,205 mi | VIN: 1FTBR1C8XLKB23657 |

Van | 3.5L V6 F DOHC 24V | Gasoline | Rear wheel drive

CARFAX HAS THE MOST  
ACCIDENT & DAMAGE  
INFORMATION



**BRANDED TITLE**

**Reconstructed, Rebuilt, Salvage**

**6 Service History Records**

**2 Previous Owners**

**Types of Owners: Commercial, Personal**

**Last Owned in North Carolina**

**18 Detailed Records Available**

This CARFAX Vehicle History Report is based only on information supplied to CARFAX and available as of 4/16/26 at 12:32:04 PM (CDT). Other information about this vehicle, including problems, may not have been reported to CARFAX. Use this report as one important tool, along with a vehicle inspection and test drive, to make a better decision about your next used car.



### Accident / Damage History

Not all accidents / issues are reported to CARFAX

#### Event 1

08/06/2024

**TOTAL LOSS VEHICLE**

- Accident reported

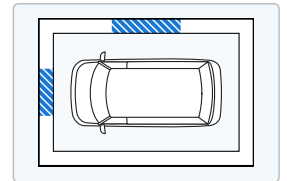

### Additional History

Not all accidents / issues are reported to CARFAX

**Owner 1**

**Owner 2**

#### Total Loss

Total Loss Reported: 08/06/2024.

Total Loss Reported

No New Issues Reported

#### Structural Damage

CARFAX recommends that you have this vehicle inspected by a collision repair specialist.

No Issues Reported

No Issues Reported





#### Airbag Deployment



No airbag deployment reported to CARFAX.





No Issues Reported

No Issues Reported



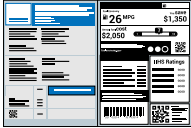

<b>Odometer Check</b> No indication of an odometer rollback.	<input checked="" type="checkbox"/> No Issues Indicated	<input checked="" type="checkbox"/> No Issues Indicated
<b>Accident / Damage</b> DMV title problems reported. Accident reported: 08/06/2024.	Severe Damage	Severe Damage
<b>Manufacturer Recall</b> No open recalls reported to CARFAX. A current list of recalls is available at Ford Motor Company.	<input checked="" type="checkbox"/> No Recalls Reported	<input checked="" type="checkbox"/> No Recalls Reported
<b>Basic Warranty</b> Original manufacturer warranty likely voided by manufacturer.	<b>Warranty Voided</b>	<b>Warranty Voided</b>

 <b>Title History</b>	 <b>Owner 1</b>	 <b>Owner 2</b>
<b>Damage Brands</b> Salvage   Junk   Rebuilt   Fire   Flood   Hail   Lemon	<b>Alert!</b> Problem Found	<b>Alert!</b> Problem Found
<b>Odometer Brands</b> Not Actual Mileage   Exceeds Mechanical Limits	No Problem	No Problem
 <b>ALERT!</b> - Severe problems were reported by a state Department of Motor Vehicles (DMV). This vehicle does not qualify for the CARFAX Buyback Guarantee.		

 <b>Ownership History</b> The number of owners is estimated	 <b>Owner 1</b>	 <b>Owner 2</b>
Year purchased	2020	2025
Type of owner	Commercial	Personal
Estimated length of ownership	3 yrs. 7 mo.	1 year
Owned in the following states/provinces	New Jersey	North Carolina
Estimated miles driven per year	5,765/yr	---
Last reported odometer reading	20,983	21,205

 <b>Detailed History</b>			
 <b>Owner 1</b> Purchased: 2020		Commercial Vehicle 5,765 mi/yr	
Date	Mileage	Source	Comments
09/19/2020		Ford Motor Company	<b>Vehicle manufactured and shipped to original dealer</b> Original Window Sticker 
10/02/2020	12	All American Ford Subaru of Old Bridge Old Bridge, NJ 732-812-4577 allamericanoldbridge.com ★ 4.7 / 5.0 1,904 Verified Reviews ❤️ 17,182 Customer Favorites	 <b>Vehicle serviced</b> - Pre-delivery inspection completed
12/08/2020	150	All American Ford Subaru of Old Bridge	<b>Vehicle sold</b>

Old Bridge, NJ  
732-591-1111  
allamericansubaru.com/  
★ 4.7 / 5.0 1,904 Verified Reviews  
♥ 17,182 Customer Favorites

12/17/2020		New Jersey Motor Vehicle Dept. Keyport, NJ Title #RV20203520632		<b>Title issued or updated</b> - Registration issued or renewed - First owner reported - Titled or registered as commercial vehicle - Vehicle color noted as White
12/21/2020	151	All American Ford Subaru of Old Bridge Old Bridge, NJ 732-812-4577 allamericaninoldbridge.com ★ 4.7 / 5.0 1,904 Verified Reviews ♥ 17,182 Customer Favorites		<b>Vehicle serviced</b> - Pre-delivery inspection completed
06/29/2021	2,774	Tom's Ford Keyport, NJ 800-510-4882 tomsford.com ★ 4.8 / 5.0 906 Verified Reviews ♥ 808 Customer Favorites		<b>Vehicle serviced</b> - Battery/charging system checked - Brakes checked - Oil and filter changed - Tire condition and pressure checked
07/23/2021		All American Ford Subaru of Old Bridge Old Bridge, NJ 732-812-4577 allamericaninoldbridge.com ★ 4.7 / 5.0 1,904 Verified Reviews ♥ 17,182 Customer Favorites		<b>Vehicle serviced</b> - Maintenance inspection completed
11/16/2021		New Jersey Motor Vehicle Dept. Keyport, NJ		<b>Registration issued or renewed</b> - Titled or registered as commercial vehicle - Vehicle color noted as White
10/18/2022		New Jersey Motor Vehicle Dept. Keyport, NJ		<b>Registration issued or renewed</b> - Titled or registered as commercial vehicle - Vehicle color noted as White
06/20/2023	16,017	Tom's Ford Keyport, NJ ★ 4.8 / 5.0 906 Verified Reviews ♥ 808 Customer Favorites		<b>Vehicle serviced</b> - Maintenance inspection completed - Brakes checked - Oil and filter changed
12/15/2023		New Jersey Motor Vehicle Dept. Keyport, NJ		<b>Registration issued or renewed</b> - Titled or registered as commercial vehicle - Vehicle color noted as White
08/06/2024		Damage Report		<b>TOTAL LOSS VEHICLE</b> - Accident reported - Damage to front - Damage to right side

**CARFAX HAS THE MOST ACCIDENT & DAMAGE INFORMATION**

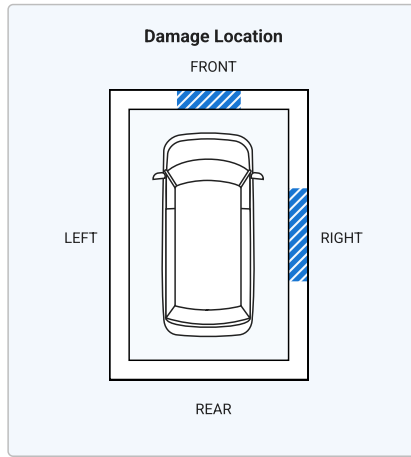

There are many reasons an insurance company will declare a vehicle a total loss. Have this vehicle inspected by a qualified technician before you buy. [Learn More](#)

08/06/2024		New Jersey Motor Vehicle Dept.		<b>Title or registration issued to insurance company</b>
08/06/2024	20,976	New Jersey Motor Vehicle Dept. Trenton, NJ Title #SP20242190529		<b>SALVAGE TITLE/CERTIFICATE ISSUED</b> - Vehicle color noted as White
10/26/2024	20,983	Asheville Ford Asheville, NC 828-253-2731 ashevilleford.com/ ★ <b>4.5 / 5.0</b> 400 Verified Reviews ❤️ <b>161</b> Customer Favorites		<b>Vehicle serviced</b> - Maintenance inspection completed

	<b>Owner 2</b> Purchased: 2025			Personal Vehicle
Date	Mileage	Source		Comments
04/14/2025	21,205	North Carolina Motor Vehicle Dept. Leicester, NC		<b>Odometer reading reported</b>
05/30/2025		North Carolina Motor Vehicle Dept. Leicester, NC Title #603262251501907		<b>New owner reported</b> - <b>SALVAGE TITLE/CERTIFICATE ISSUED</b> - <b>RECONSTRUCTED TITLE ISSUED</b> - <b>REBUILT TITLE ISSUED</b>
03/31/2026		Ford Motor Company		<b>Manufacturer Customer Satisfaction issued</b> - Program #25N17 REAR VIEW CAMERA REPLACEMENT IF REQUIRED AFTER DEALER EVALUATION  Locate an authorized Ford or Lincoln dealer or call 866-436-7332 to obtain more information

Have Questions? Consumers, please visit our Help Center at [www.carfax.com](http://www.carfax.com). Dealers or Subscribers, please visit our Help Center at [www.carfaxonline.com](http://www.carfaxonline.com).

**CARFAX Glossary**

**Accident Indicator**

CARFAX receives information about accidents in all 50 states, the District of Columbia and Canada.

Not every accident is reported to CARFAX. As details about the accident become available, those additional details are added to the CARFAX Vehicle History Report. CARFAX recommends that you have this vehicle inspected by a qualified mechanic.

- According to the National Safety Council, Injury Facts, 2021 edition, 5% of the 276 million registered vehicles in the U.S. were involved in an accident in 2019. Over 77% of these were considered minor or moderate.
- This CARFAX Vehicle History Report is based only on information supplied to CARFAX and available as of 4/16/26 at 12:32:04 PM (CDT). Other information about this vehicle, including problems, may not have been reported to CARFAX. Use this report as one important tool, along with a vehicle inspection and test drive, to make a better decision about your next used car.

**Commercial**

Vehicle was registered for business purposes.

**Damage Indicator**

Damage can be a result of many different types of events. Examples include contact with objects (other cars, trees, traffic signs, road debris, etc), vandalism, or weather-related events. Not every damage event is reported to CARFAX. As details about the damage event become available, those additional details are added to the CARFAX Vehicle History Report. CARFAX recommends that you have this vehicle inspected by a qualified mechanic.

- This CARFAX Vehicle History Report is based only on information supplied to CARFAX and available as of 4/16/26 at 12:32:04 PM (CDT). Other information about this vehicle, including problems, may not have been reported to CARFAX. Use this report as one important tool, along with a vehicle inspection and test drive, to make a better decision about your next used car.

**First Owner**

When the first owner(s) obtains a title from a Department of Motor Vehicles as proof of ownership.

**Ford or Lincoln Mercury Recall**

The Ford Motor Company provides CARFAX with Field Service Action and recall information regarding safety, compliance and emissions programs announced since 2000 for a specific vehicle. For complete information regarding programs or concerns about this vehicle, please contact a local Ford or Lincoln Mercury Dealer.

**New Owner Reported**

When a vehicle is sold to a new owner, the Title must be transferred to the new owner(s) at a Department of Motor Vehicles.

**Ownership History**

CARFAX defines an owner as an individual or business that possesses and uses a vehicle. Not all title transactions represent changes in ownership. To provide estimated number of owners, CARFAX proprietary technology analyzes all the events in a vehicle history. Estimated ownership is available for vehicles manufactured after 1991 and titled solely in the US including Puerto Rico. Dealers sometimes opt to take ownership of a vehicle and are required to in the following states: Maine, Massachusetts, New Jersey, Ohio, Oklahoma, Pennsylvania and South Dakota. Please consider this as you review a vehicle's estimated ownership history.

**Rebuilt/Reconstructed Title**

A Rebuilt/Reconstructed vehicle is a salvage vehicle that has been repaired and restored to operation. These vehicles are often severely damaged before they are rebuilt and refurbished parts are typically used during reconstruction. In most states, an inspection of the vehicle is required before the vehicle is allowed to return to the road.

**Salvage Title**

A Salvage Title is issued on a vehicle damaged to the extent that the cost of repairing the vehicle exceeds approximately 75% of its pre-damage value. This damage threshold may vary by state. Some states treat Junk titles the same as Salvage but the majority use this title to indicate that a vehicle is not road worthy and cannot be titled again in that state. The following eleven states also use Salvage titles to identify stolen vehicles - AZ, FL, GA, IL, MD, MN, NJ, NM, NY, OK and OR.

**Title Issued**

A state issues a title to provide a vehicle owner with proof of ownership. Each title has a unique number. Each title or registration record on a CARFAX report does not necessarily indicate a change in ownership. In Canada, a registration and bill of sale are used as proof of ownership.

**Total Loss Vehicle**

An insurance or fleet company declares a vehicle a total loss when a claim exceeds approximately 75% of its pre-damage value or if the vehicle is stolen and not recovered. This damage threshold varies by company. These companies typically take possession and obtain the title. Not all total loss vehicles result in a DMV-reported branded title. This may occur when an insurance company's definition of a total loss is different than the state DMV's definition for a branded title or when the owner of the vehicle is a self-insured company, like a fleet or rental company.

Follow Us:  [facebook.com/CARFAX](https://facebook.com/CARFAX)  [@CARFAXinc](https://twitter.com/CARFAXinc)  [About CARFAX](#)

CARFAX DEPENDS ON ITS SOURCES FOR THE ACCURACY AND RELIABILITY OF ITS INFORMATION. THEREFORE, NO RESPONSIBILITY IS ASSUMED BY CARFAX OR ITS AGENTS FOR ERRORS OR OMISSIONS IN THIS REPORT. CARFAX FURTHER EXPRESSLY DISCLAIMS ALL WARRANTIES, EXPRESS OR IMPLIED, INCLUDING ANY IMPLIED WARRANTIES OF MERCHANTABILITY OR FITNESS FOR A PARTICULAR PURPOSE.

© 2026 CARFAX, Inc., part of S&P Global. All rights reserved.  
4/16/26 12:32:04 PM (CDT)

**I have reviewed and received a copy of the CARFAX Vehicle History Report for this 2020 FORD TRANSIT vehicle (VIN: 1FTBR1C8XLKB23657), which is based on information supplied to CARFAX and available as of 4/16/26 at 1:32 PM (EDT).**

Customer Signature

Date

Dealer Signature

Date